

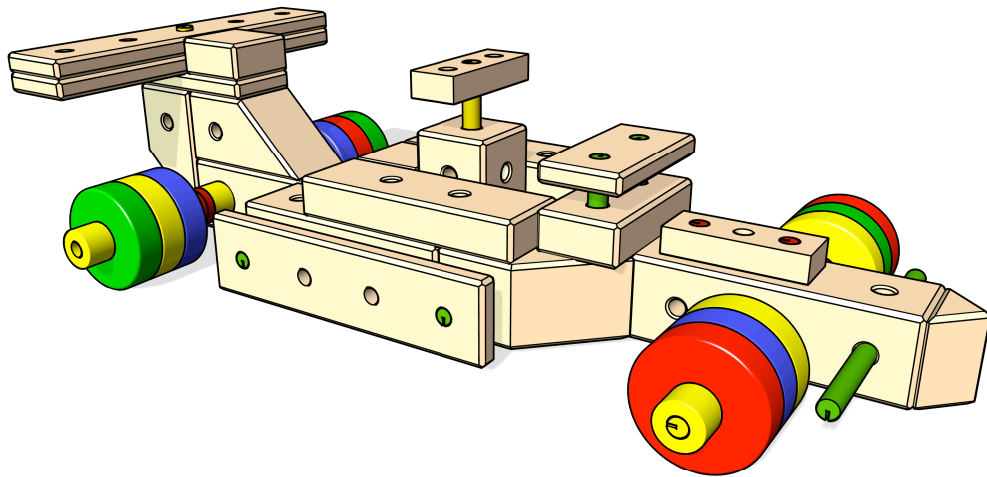























405 Rennauto / Racing Car

LEVEL



- | | | | | |
|--|--|--|---|---|
| 1x  | 1x  | 2x  | 8x  | 14x  |
| 1x  | 4x  | 2x  | 26x  | 7x  |
| 2x  | 2x  | 2x  | 2x  | 2x  |
| 2x  | 1x  | 2x  | 4x  | |
| | 2x  | 3x  | | 3x  |
| | | 3x  | | 3x  |

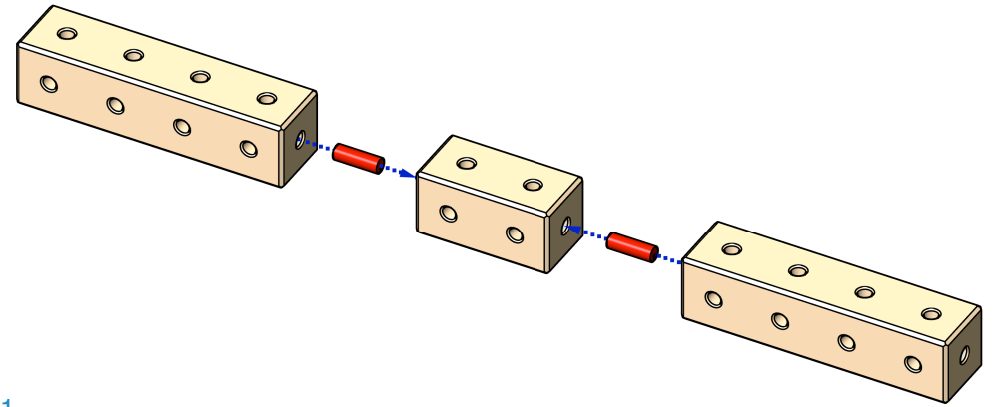

1

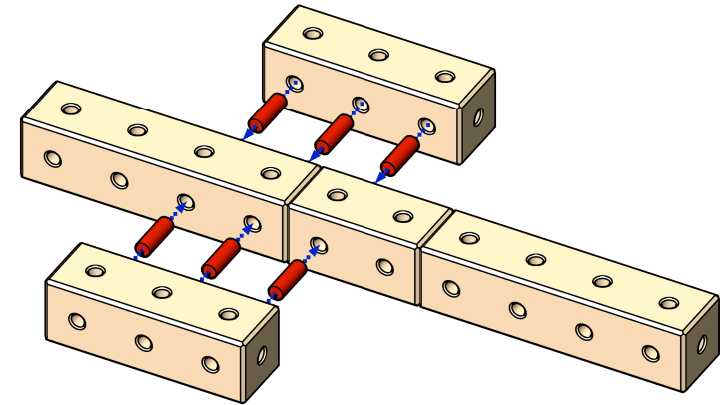

2

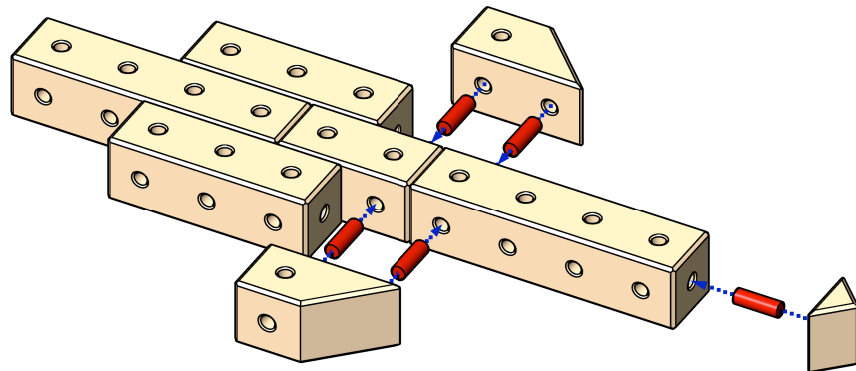

3

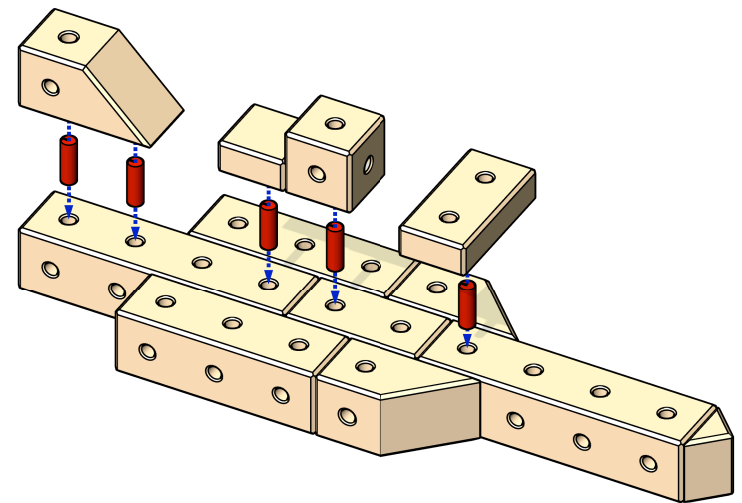

4

5

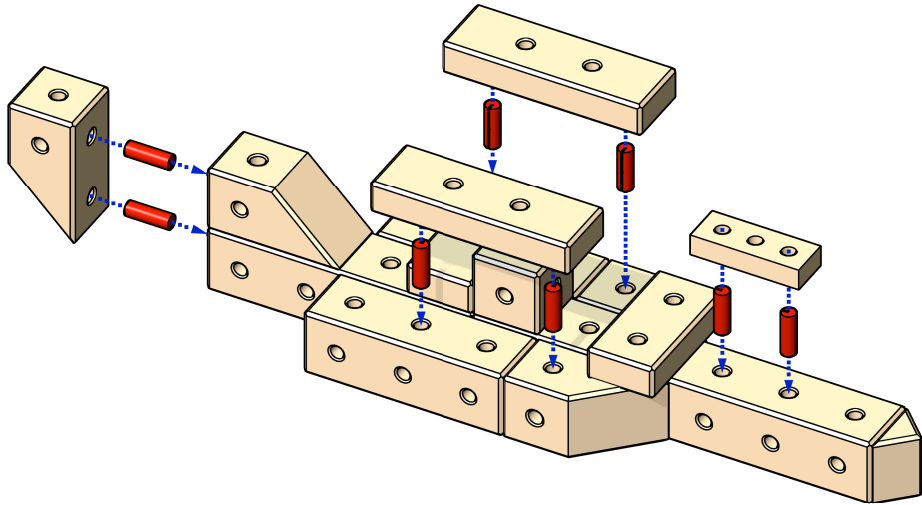

6

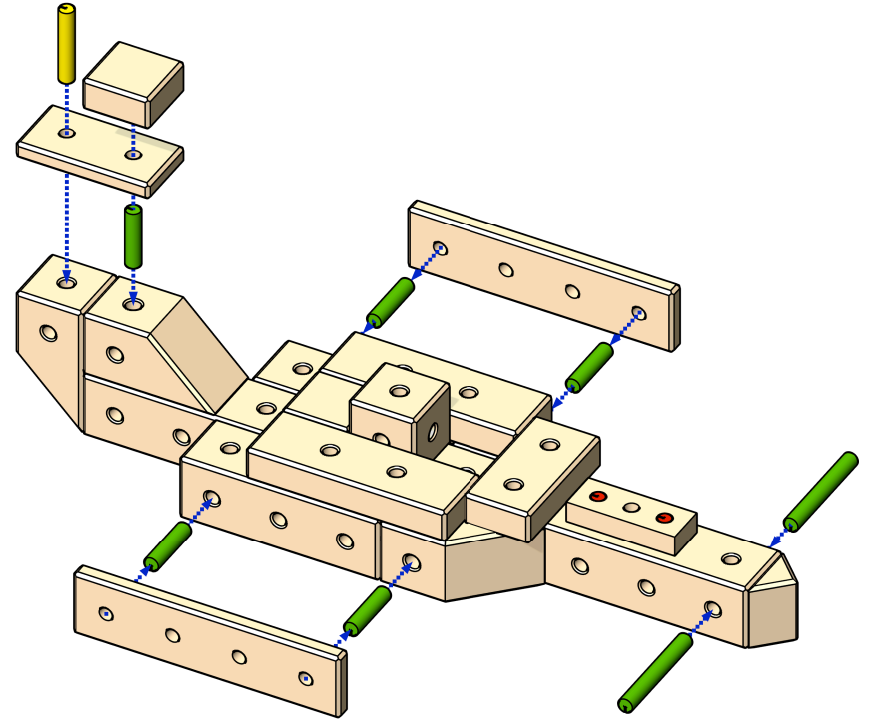

7

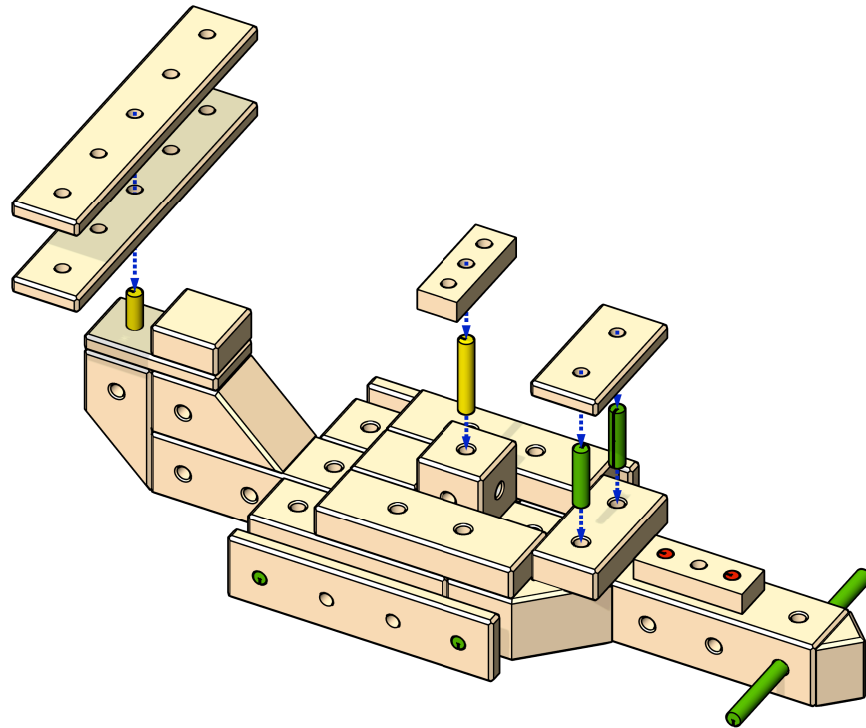

8

