

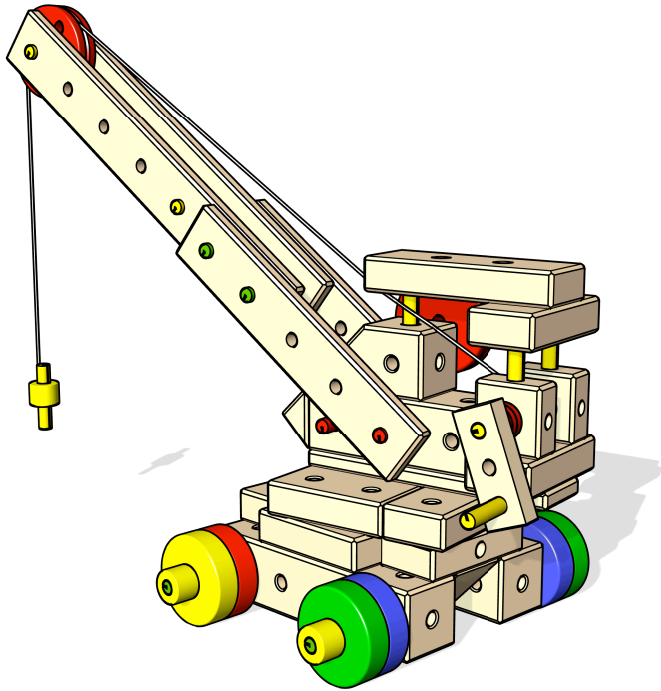

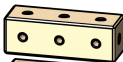























404 Kran / Crane

LEVEL



- | | | | | |
|--|--|---|---|--|
| 1x  3 | 2x  2 | 1x  4 | 2x  2x  | 25x  |
| 2x  4 | 2x  3 | 2x  5 | 2x  2x  | 3x  |
| | | 2x  7 | 6x  8x  | 7x  |
| 1x  1/2 | 2x  6 | 2x  1x  | 2x  | 6x  |
| 3x  | | 2x  | 2x  | 1x  |
| | | |  110 cm | |

A

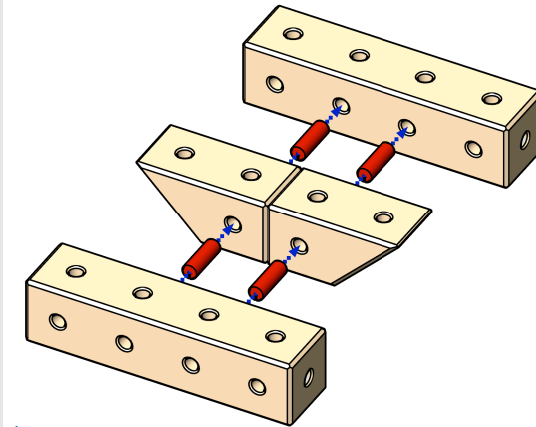

1

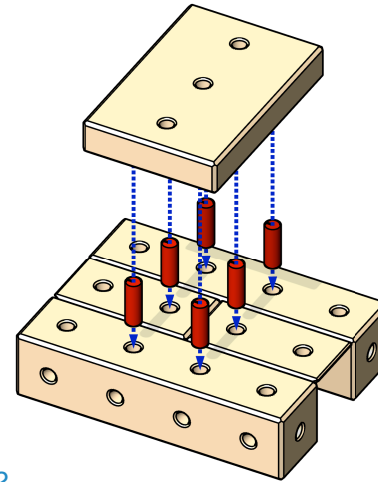

2

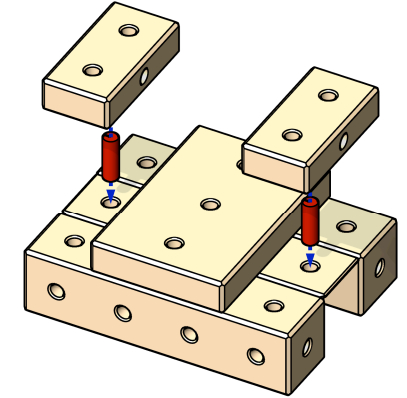

3

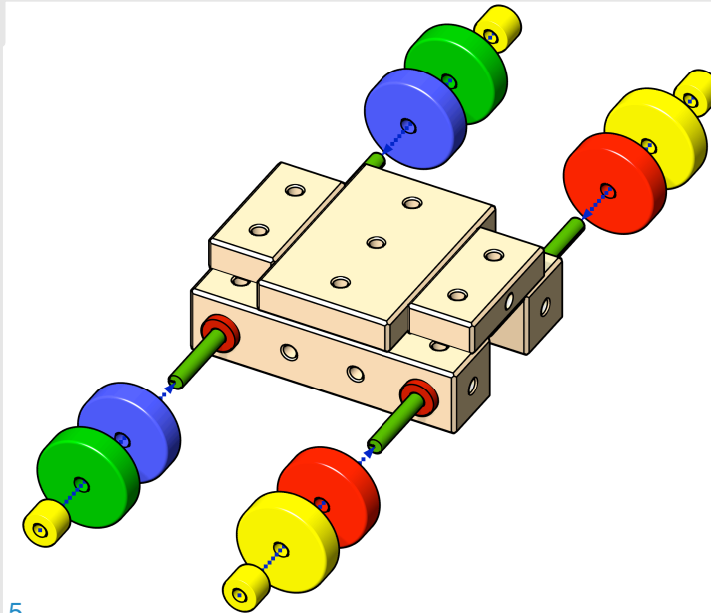

5

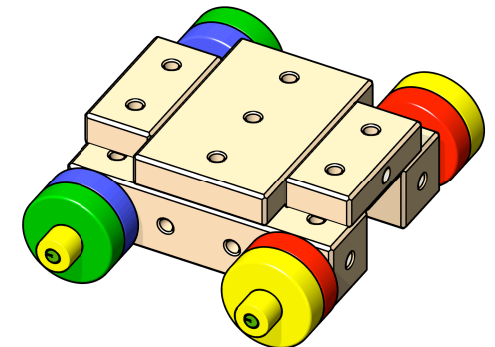

6

4

A

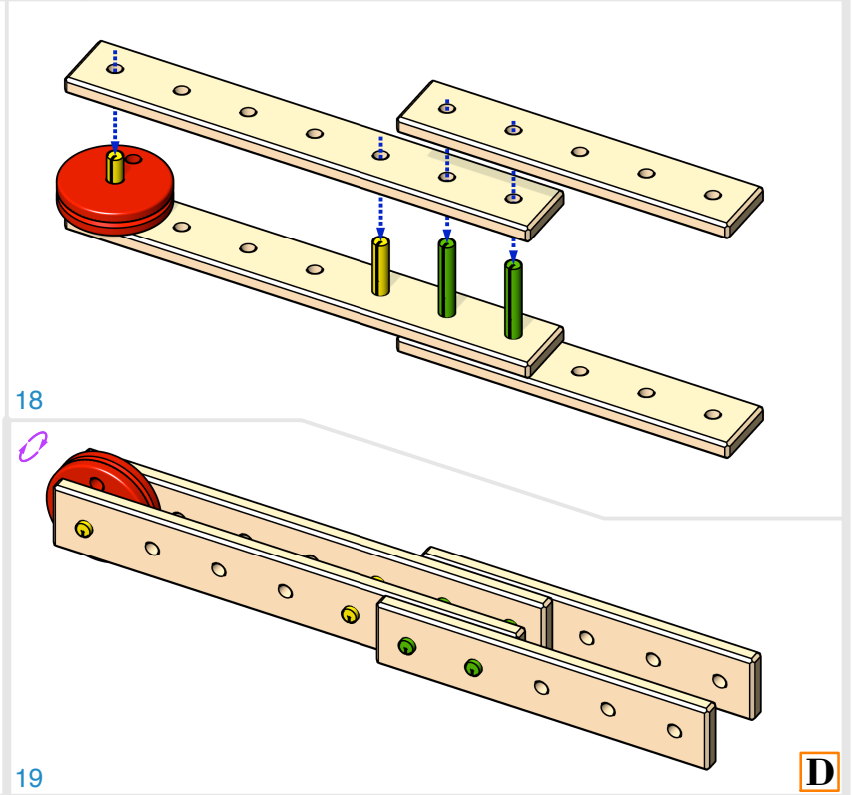
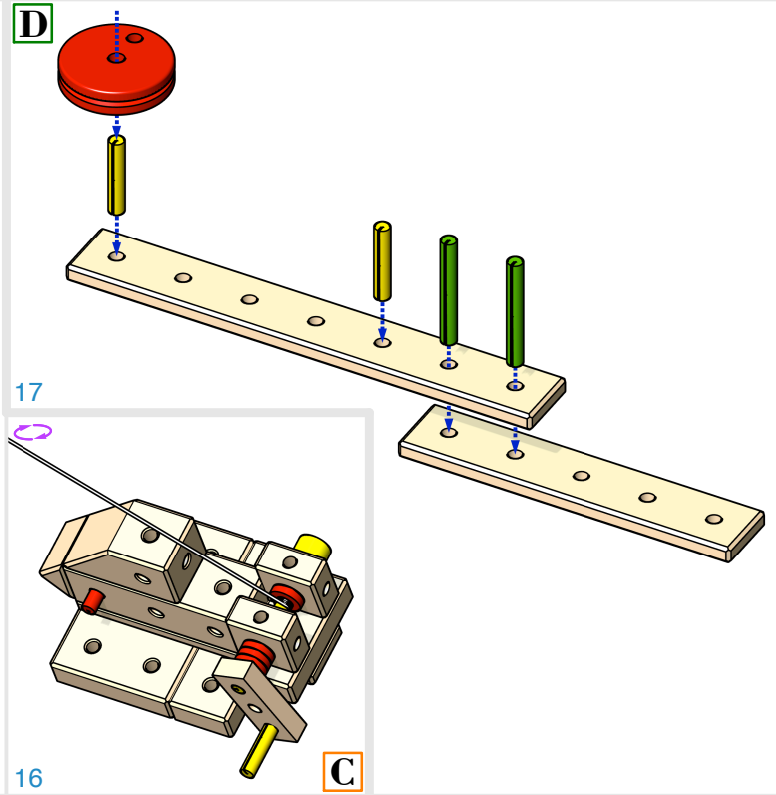
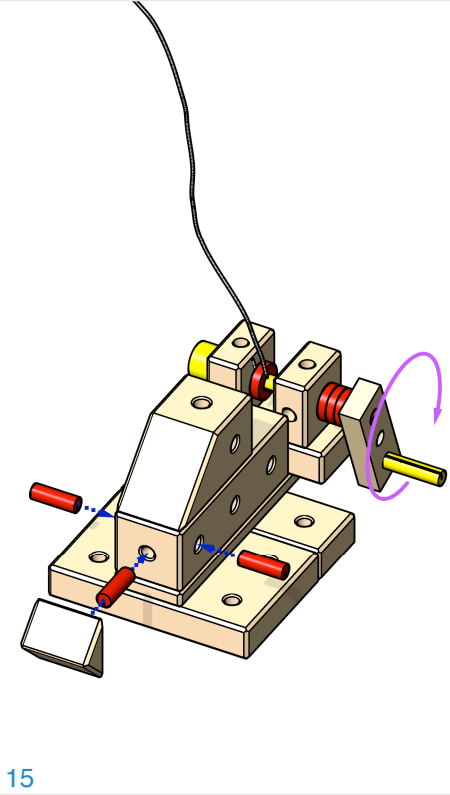
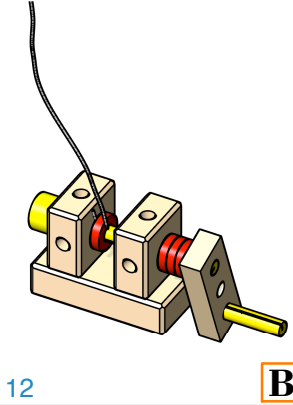
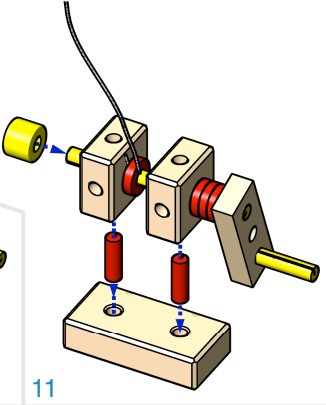
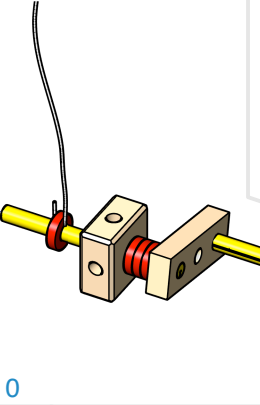
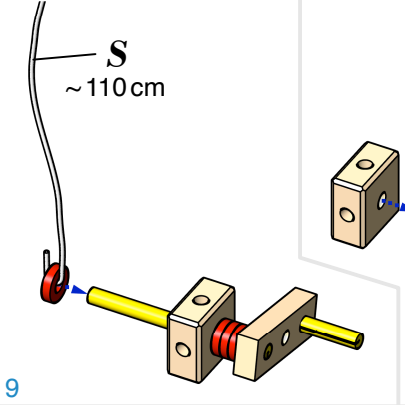
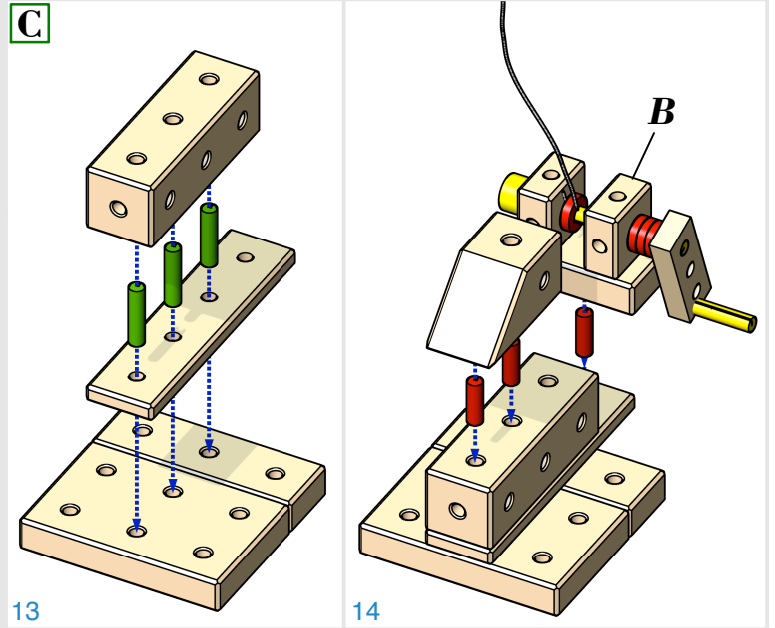
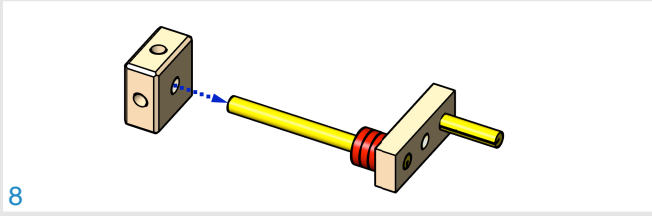
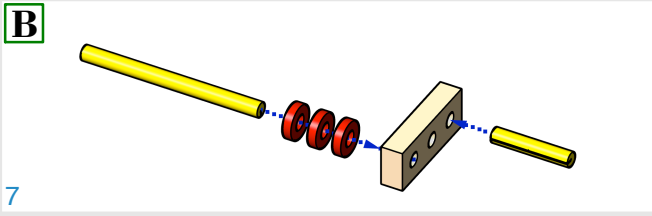

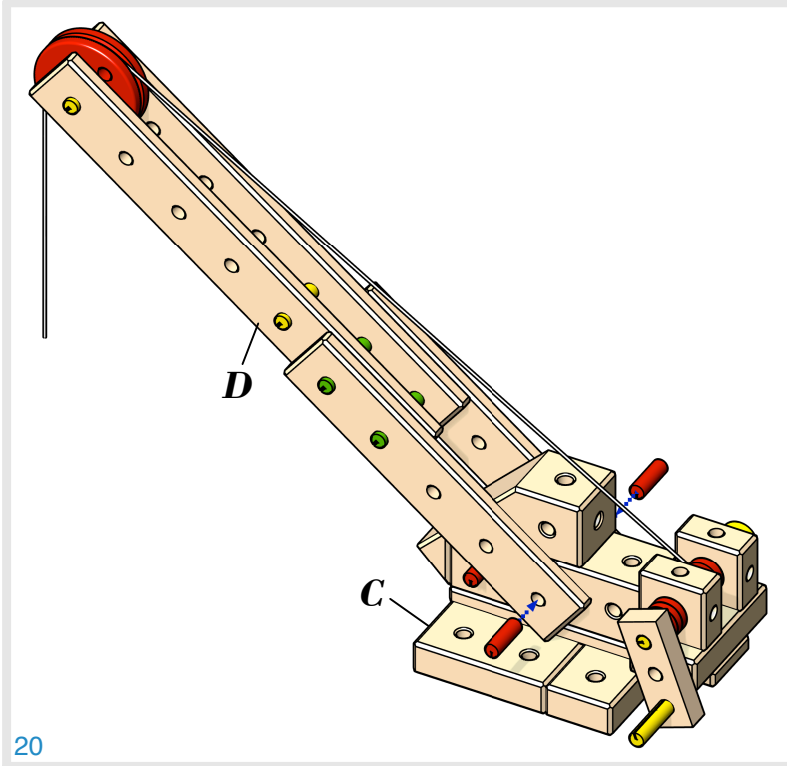

20

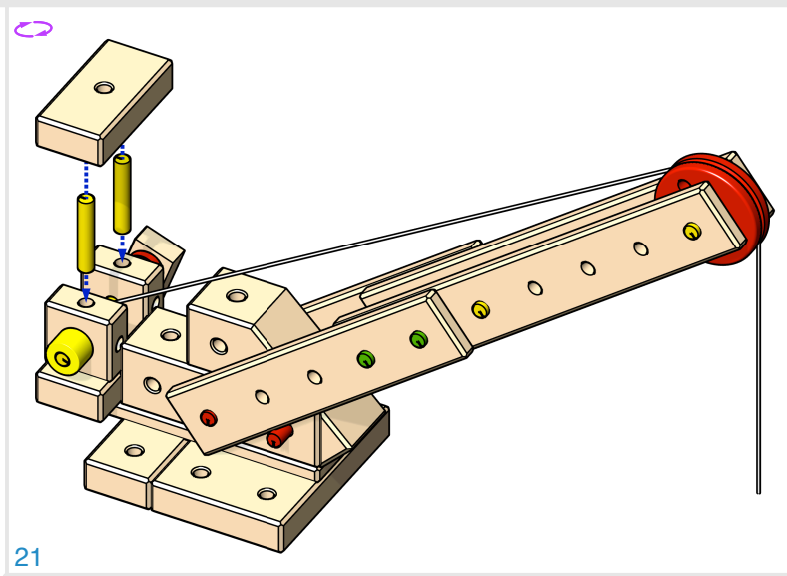

21

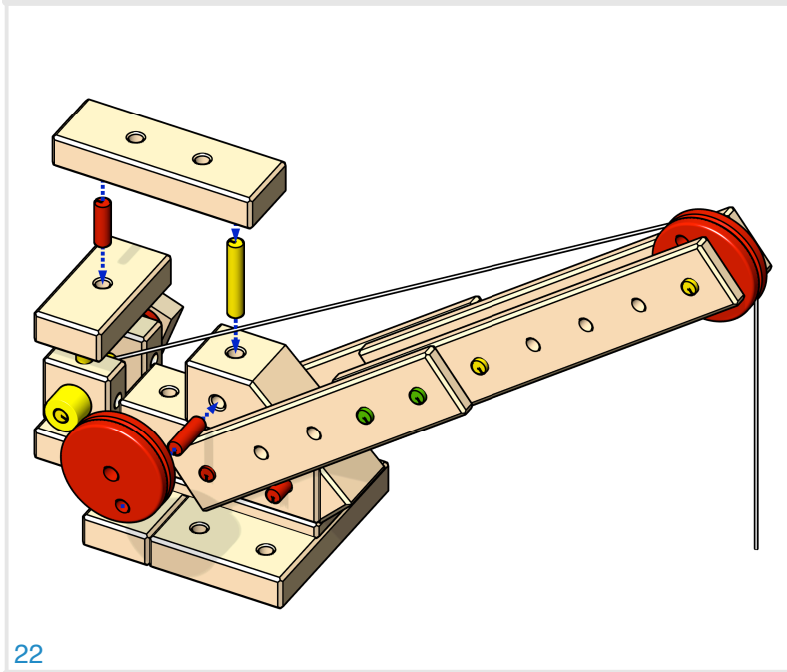

22

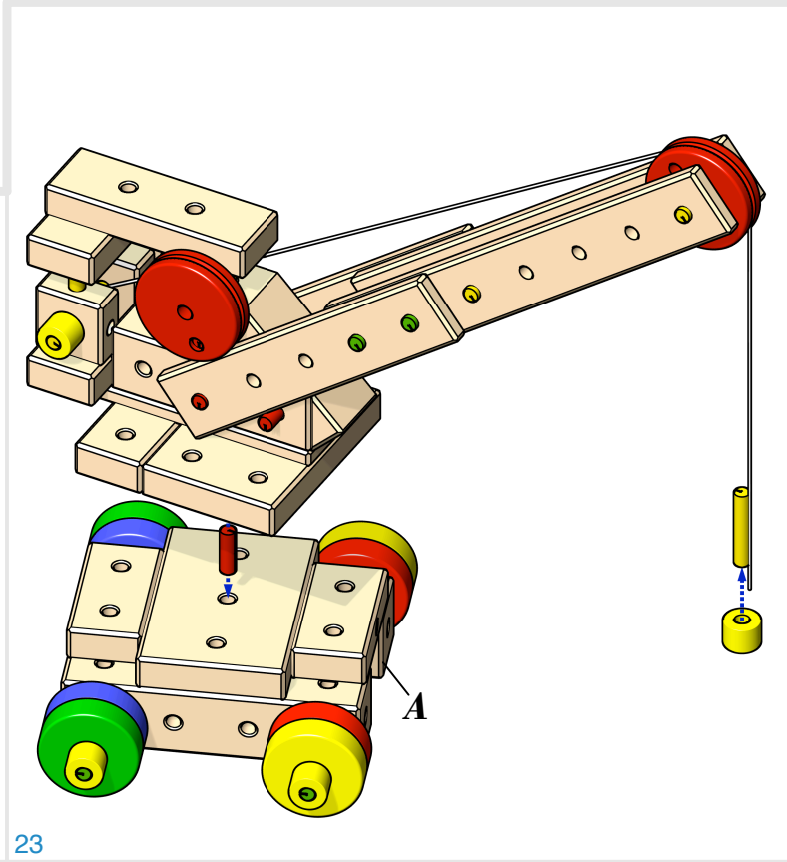

23

