

















- 2x  1
- 2x  3
- 1x  4
- 2x  2
- 2x  3
- 2x  1/2
- 2x  1
- 3x  3x 
- 3x  3x 
- 14x 
- 12x 
- 16x 
- 6x 
- 



7

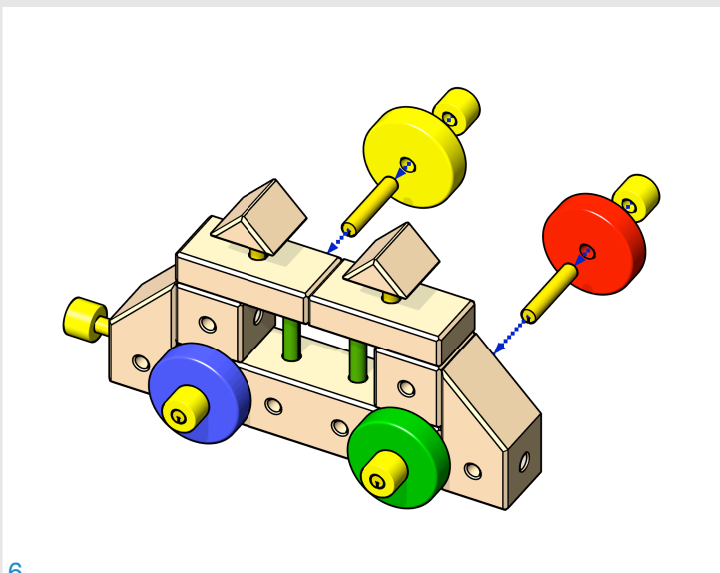
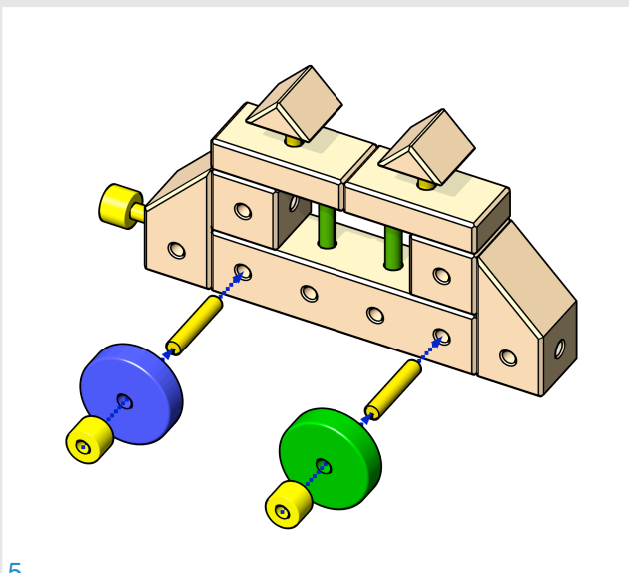
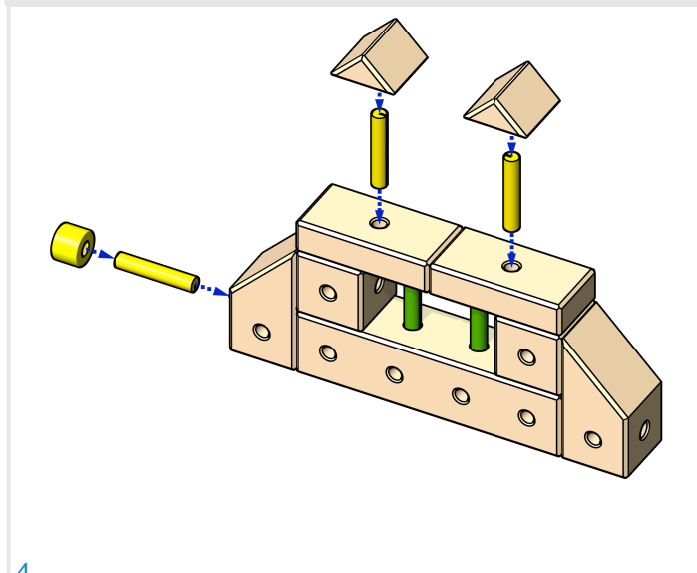
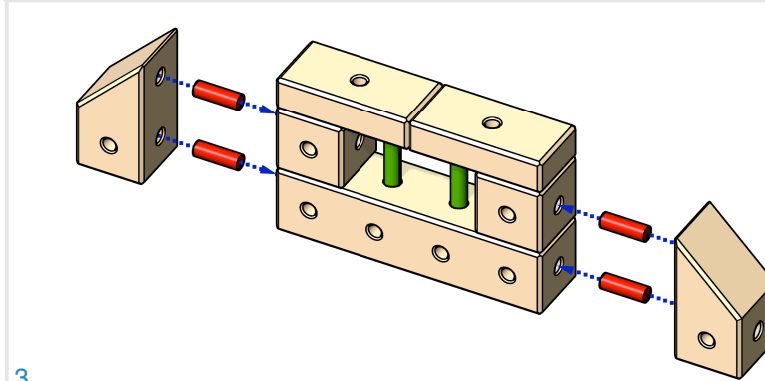
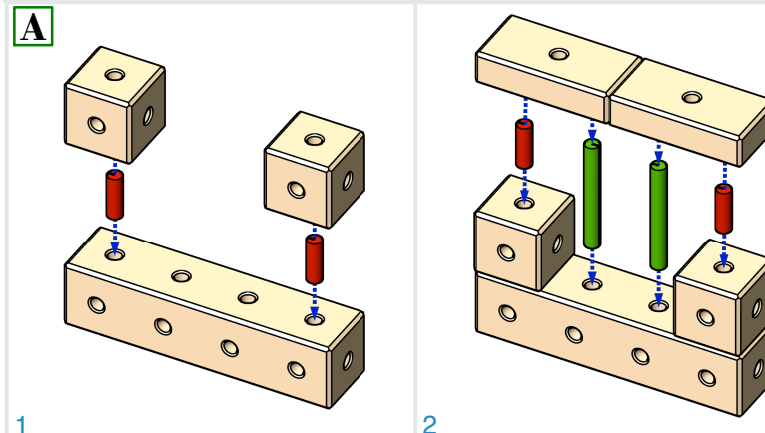
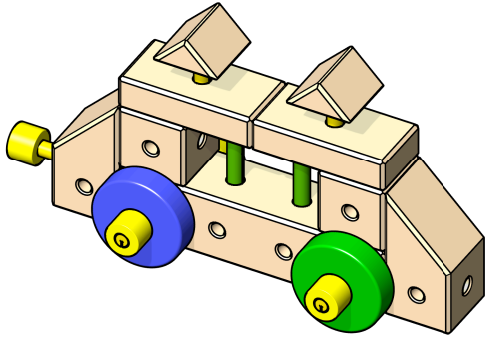

B

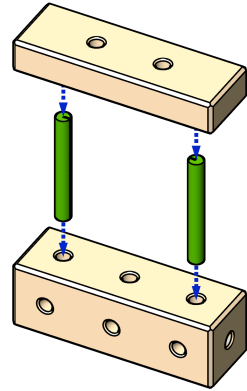

A

8

9

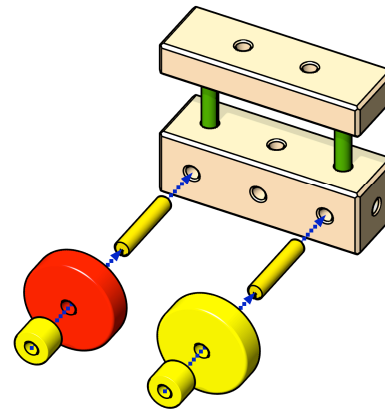

10

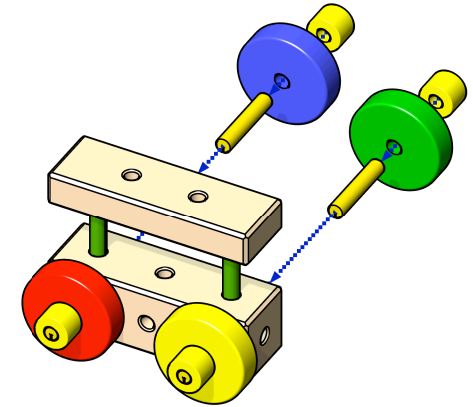

11

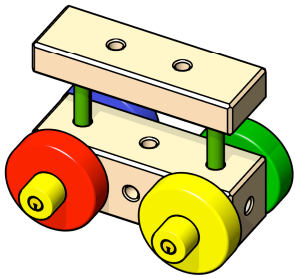

C

B

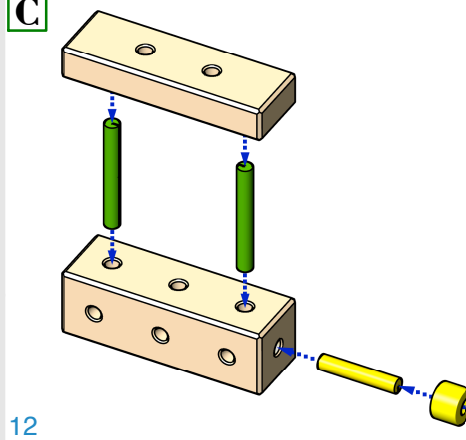

12

13

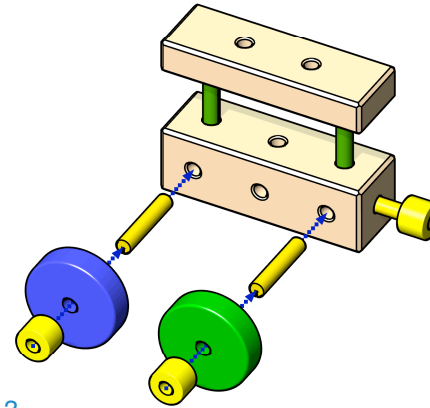

14

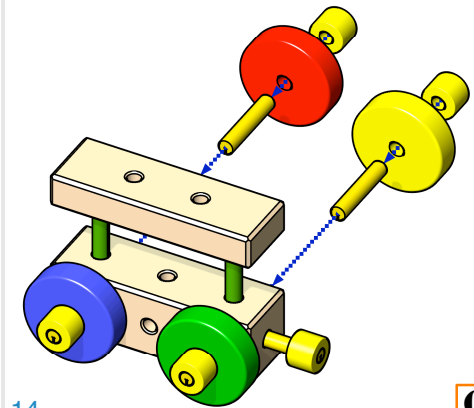

C

15

