

319 Dampfzug / Steam Train

LEVEL

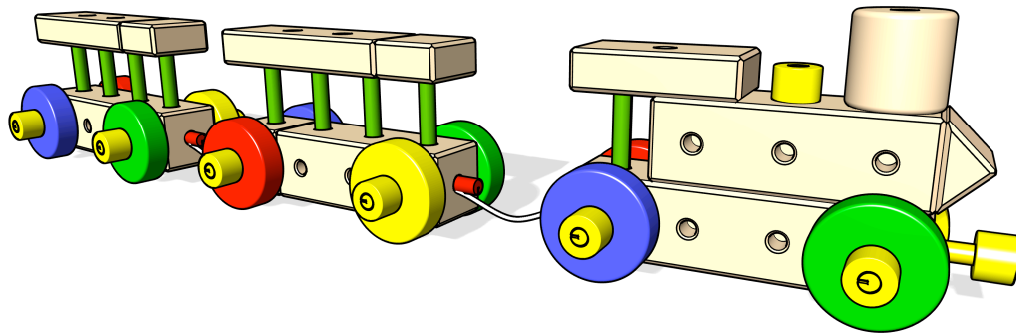

- 1x 1
- 2x 3
- 2x 4
- 1x 1/2
- 2x 1
- 1x 2
- 2x 3
- 1x 1
- 3x 3
- 3x 3
- 3x 3
- 3x 3
- 14x 14
- 11x 11
- 13x 13
- 9x 9
- 1

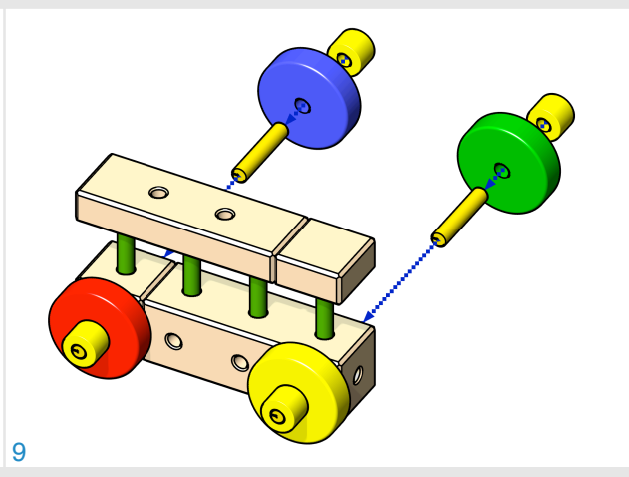
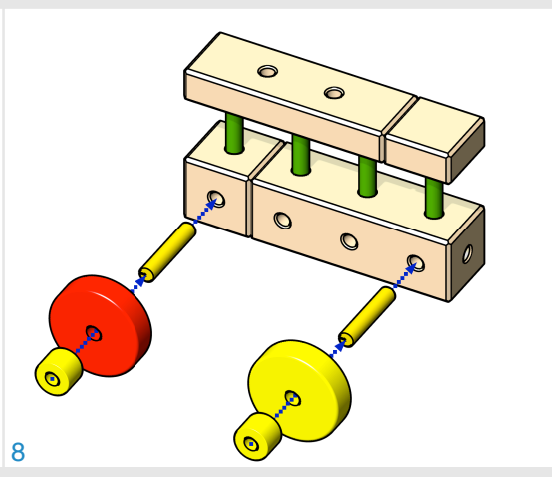
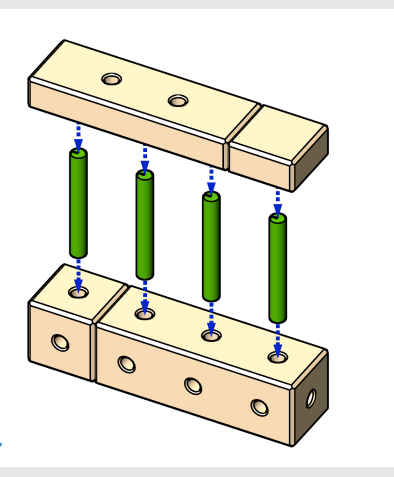
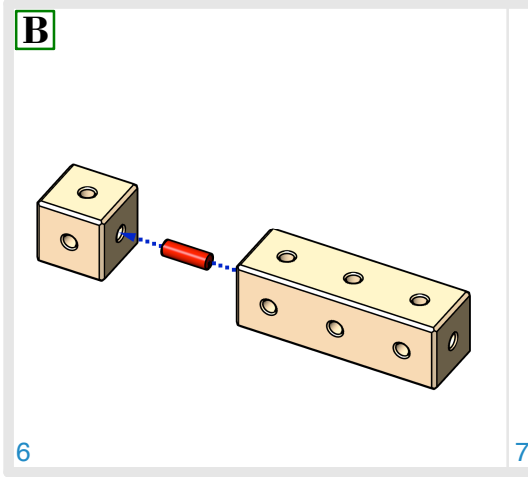
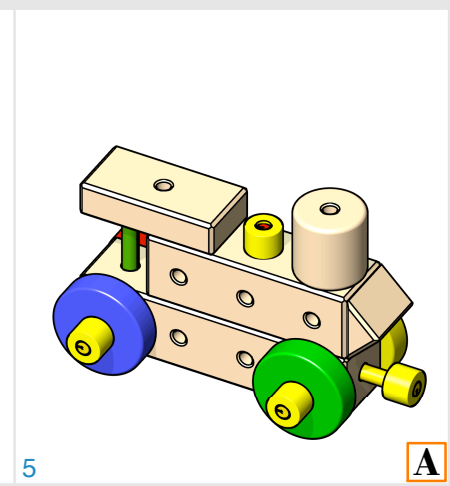
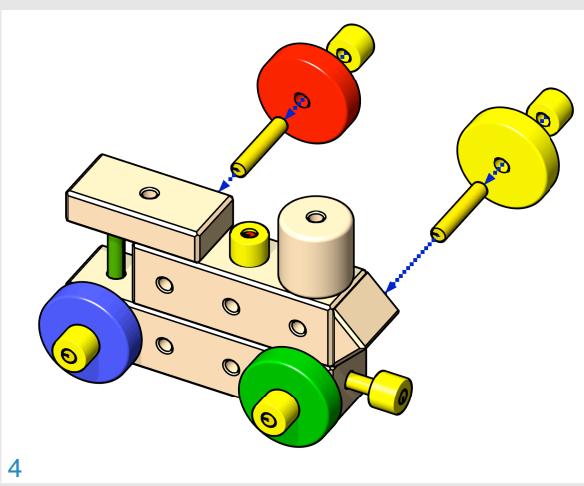
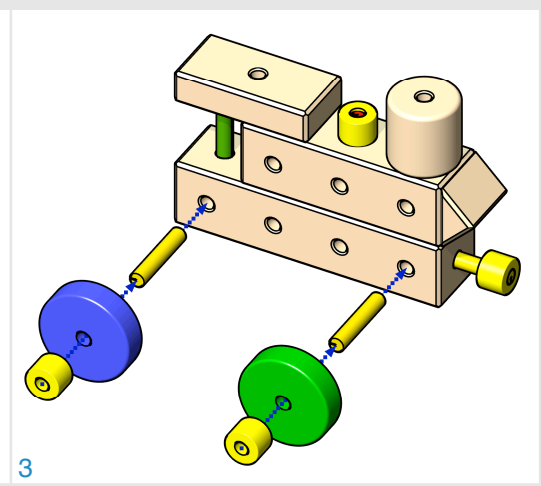
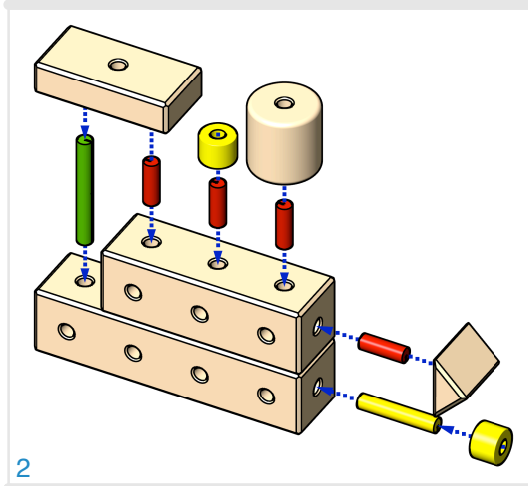
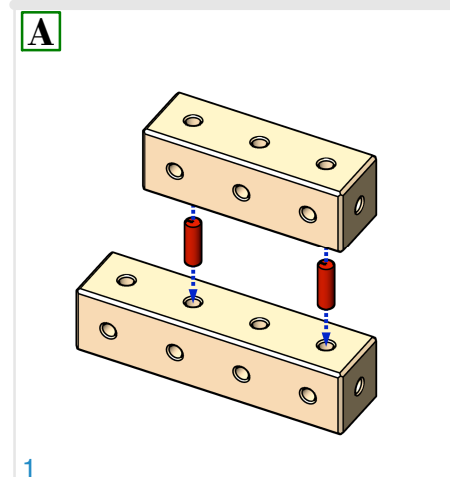

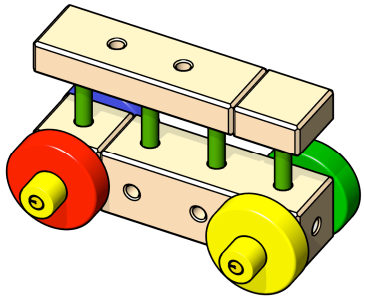

10

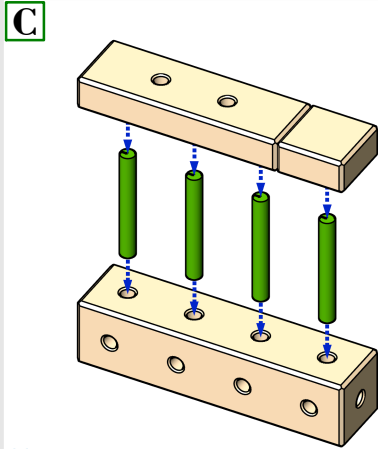

B 11

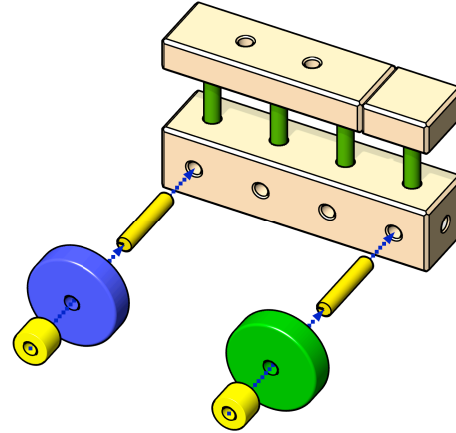

12

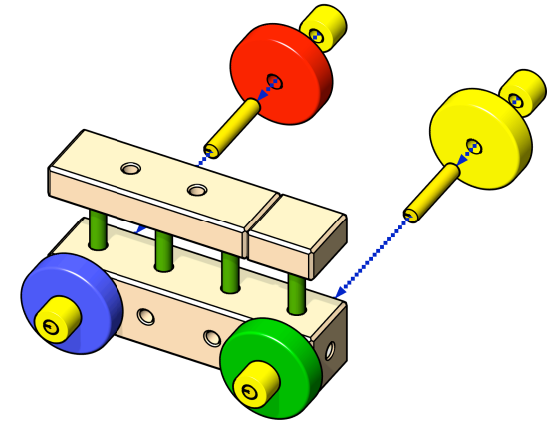

13

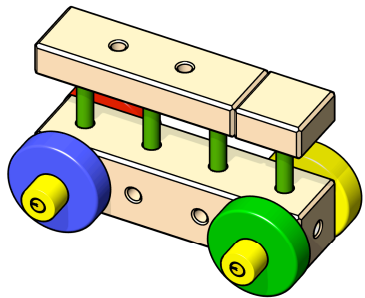

14

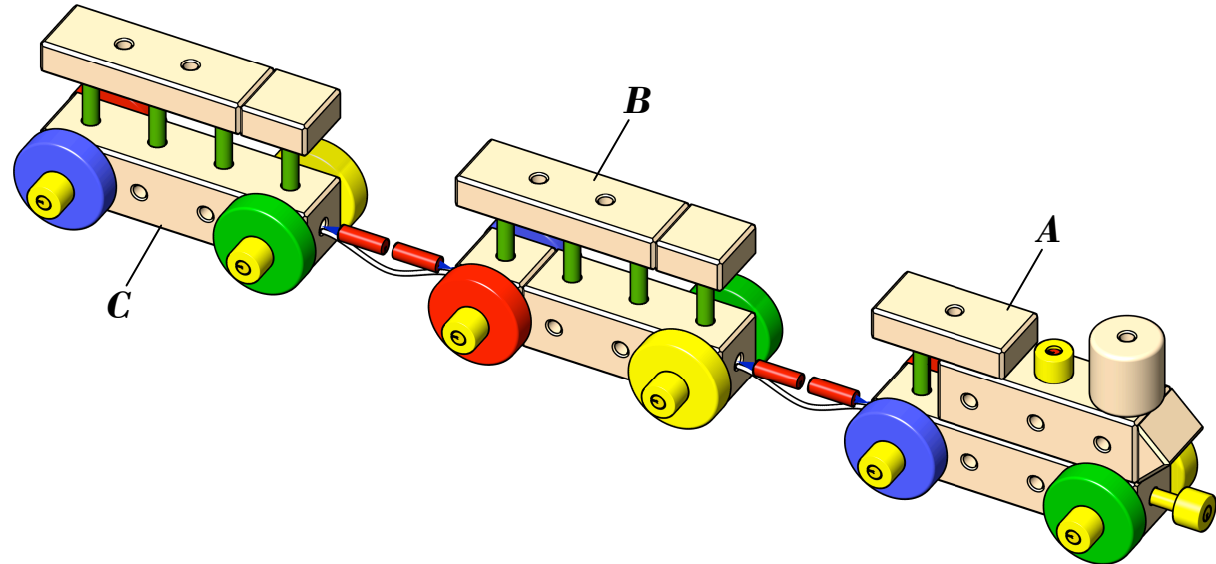

C 15

